

**Montage-handleiding elektrokabelset voor
trekhaak met 12-N contactdoos
vlg. DIN/ISO norm 1724**

**Fitting instructions electric wiringkit
towbar with 12-N socket up to
DIN/ISO norm 1724**

**Einbauanleitung Elektrosatz
Anhängervorrichtung mit 12-N Steckdose
lt. DIN/ISO Norm 1724**

**Instructions de montage du faisceau
électrique pour crochet d'attelage
conforme à la norme DIN/ISO 1724
prise 12-N**

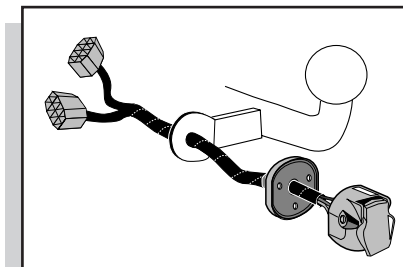

**AUDI A4 AVANT 1996-
Mit Check Kontrol**

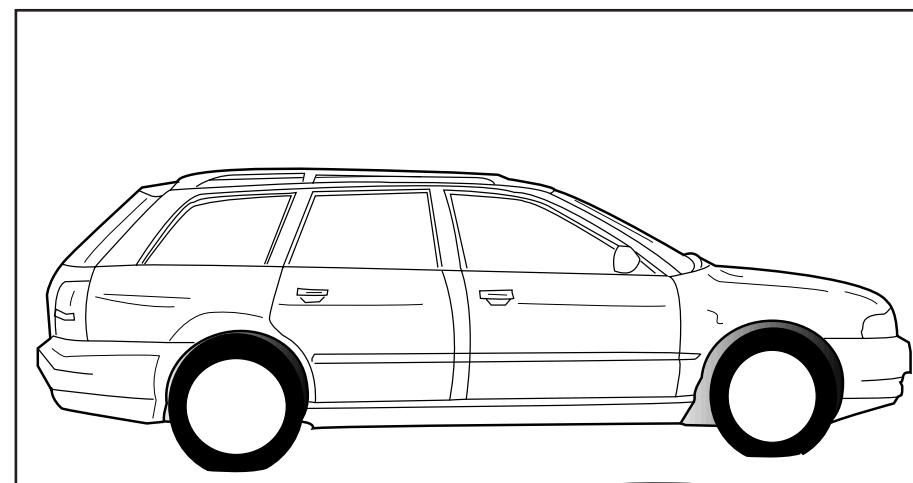

Bestel Nr.: VAG-040-B

AUDI

A 4 AVANT

WITH CHECK CONTROL

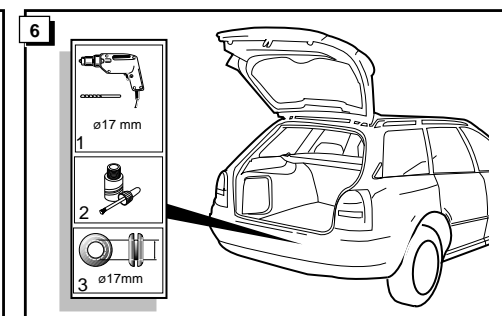
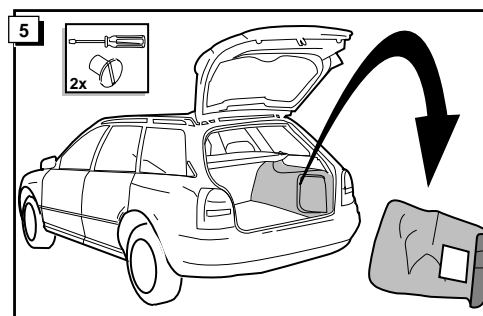
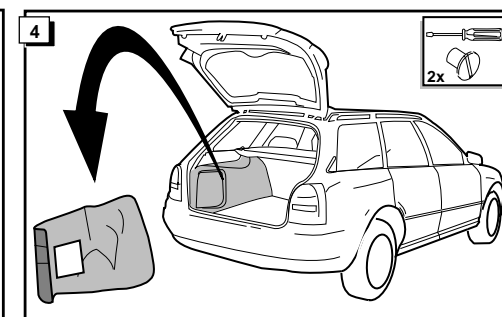
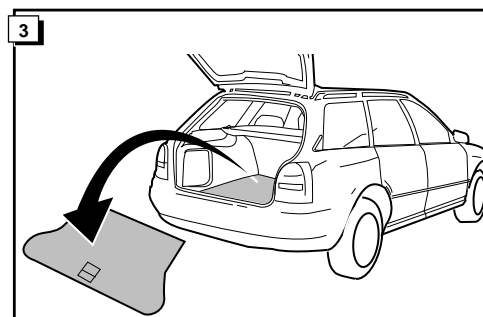
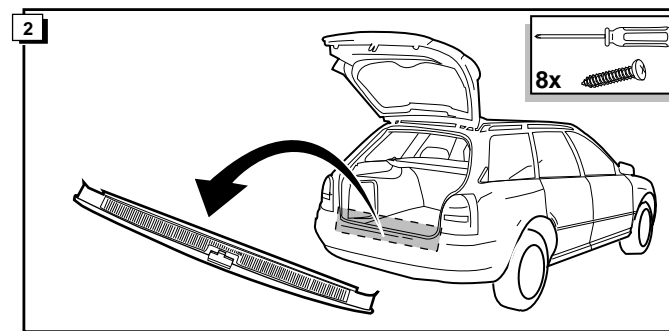
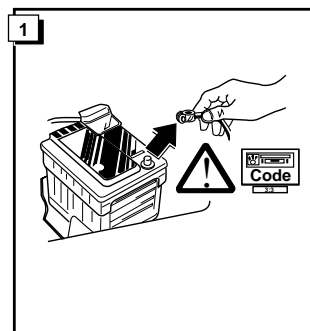
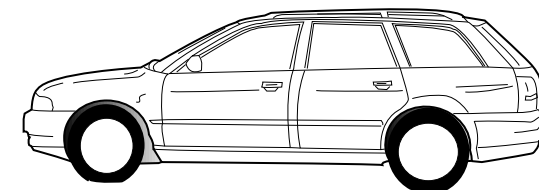

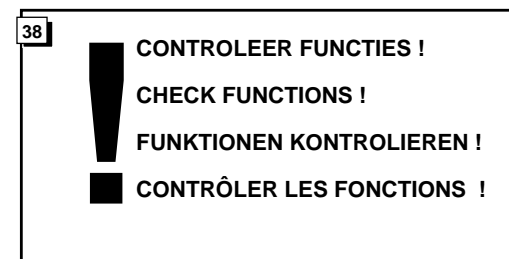
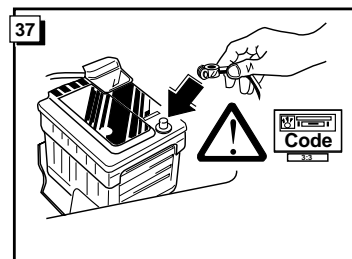
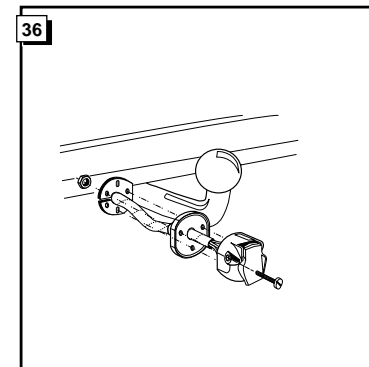
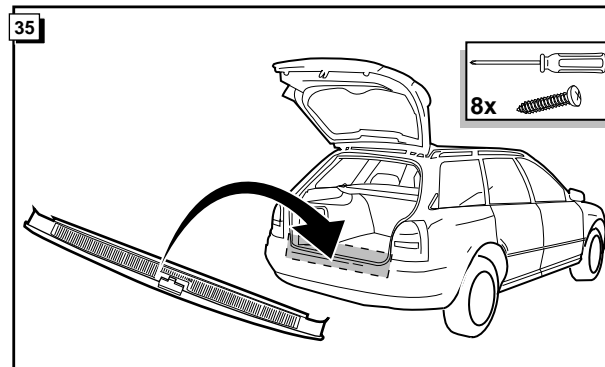
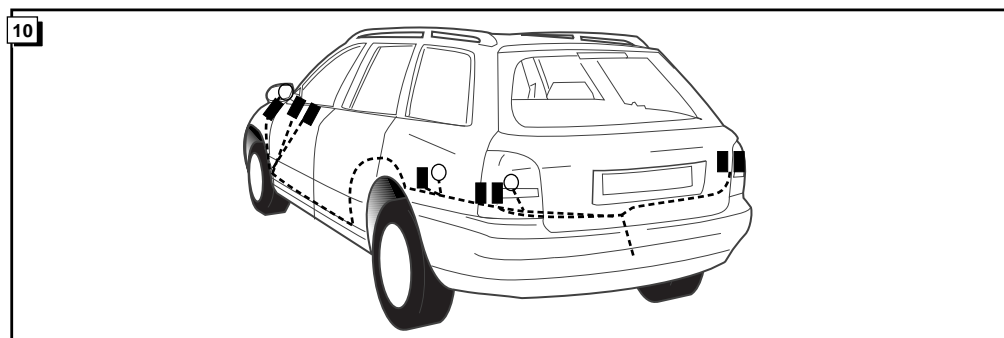
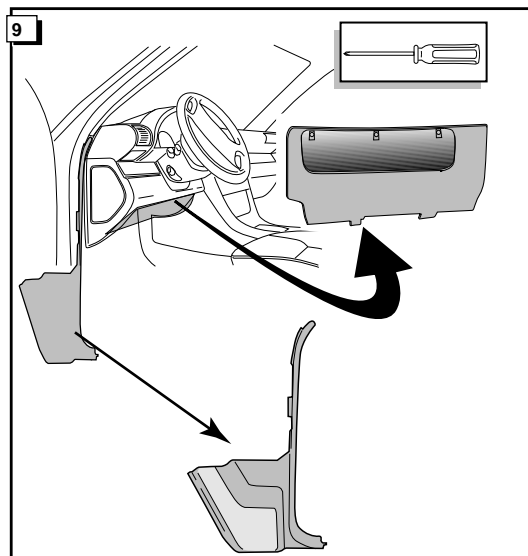
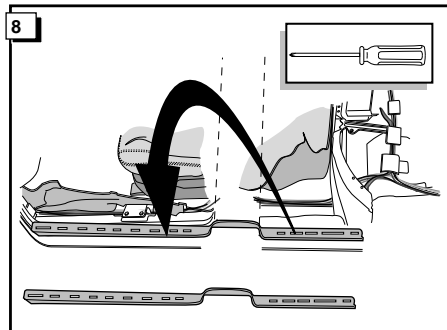
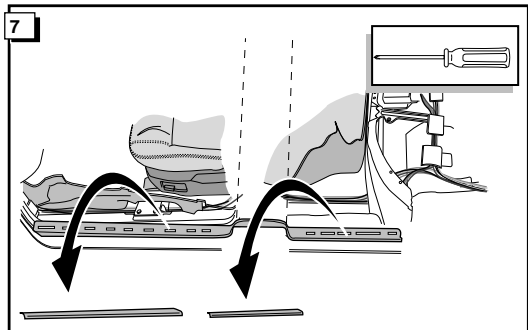

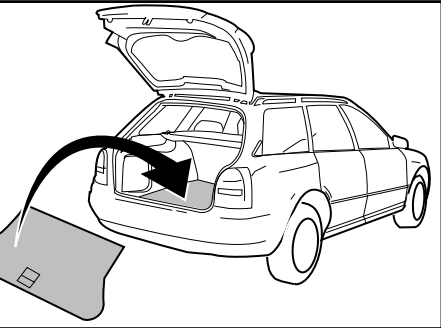
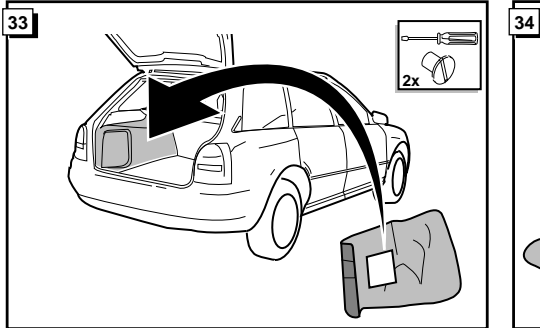
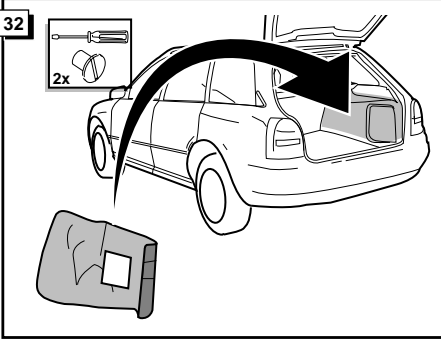
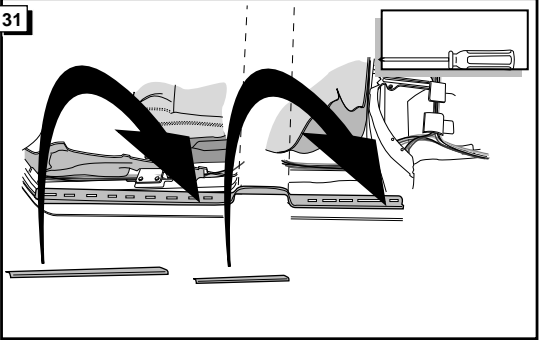
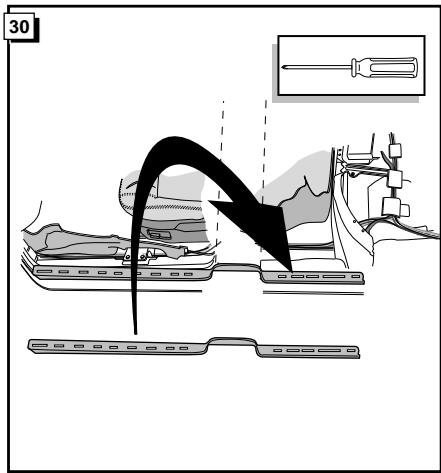
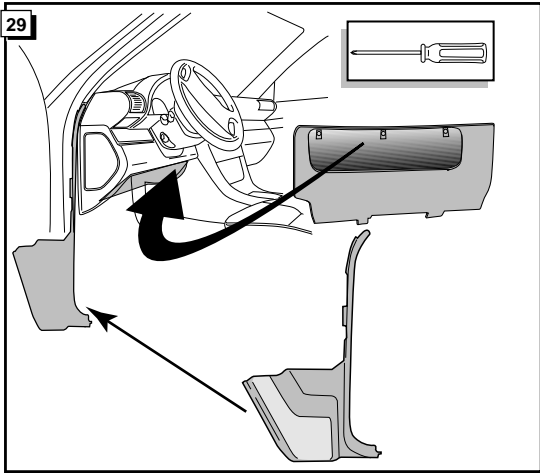

11

	NL	GB	D	FR
1 = L	GEEL	YELLOW	GELB	JAUNE
2 = 54-G	BLAUW	BLUE	BLAU	BLEU
3 = 31	WIT	WHITE	WEIß	BLANC
4 = R	GROEN	GREEN	GRÜN	VERT
5 = 58-R	BRUIN	BROWN	BRAUN	MARRON
6 = 54	ROOD	RED	ROT	ROUGE
7 = 58-L	ZWART	BLACK	SCHWARZ	NOIR
8 = 58-b	GRIJS	GREY	GRAU	GRIS

KNIPPERLICHT LINKS
 L.H. INDICATOR
 BLINKER LINKS
 CLIGNOTANT GAUCHE
 1
 2
 3
 4
 5
 6
 7
 8
 MASSA
 EARTH
 MASSE
 STOP
 REMLICHTEN
 BRAKELICHTS
 BREMSLEUCHTE
 FEUX DE STOP
 ACHTERLICHT LINKS
 L.H. REARLIGHT
 SCHLÜßLEUCHTE LINKS
 FEU ARRIERE GAUCHE
 KNIPPERLICHT RECHTS
 R.H. INDICATOR
 BLINKER RECHTS
 CLIGNOTANT DROIT
 ACHTERLICHT RECHTS
 R.H. REARLIGHT
 SCHLÜßLEUCHTE RECHTS
 FEU ARRIERE DROIT

